

# EURO TRACK – 3A

## Rails apparents et encastrés 3 allumages



**Rails apparents et encastrés universels 3 allumages disponibles en longueur de 1, 2, 3 mètres et en 3 finitions: 1 (gris) / 2 (noir) / 3 (blanc).**

Les accessoires d'alimentation, de raccord et de finition sont les mêmes pour les 2 versions.

Code produit

Code produit	Description	Long.
XTS 4100 - *	Apparent 3 allumages	1 m
XTS 4200 - *	Apparent 3 allumages	2 m
XTS 4300 - *	Apparent 3 allumages	3 m

Code produit

Code produit	Description	Long.
XTSF 4100 - *	Encastré 3 alimentations	1 m
XTSF 4200 - *	Encastré 3 alimentations	2 m
XTSF 4300 - *	Encastré 3 alimentations	3 m

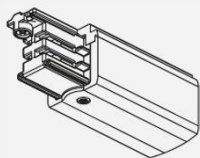
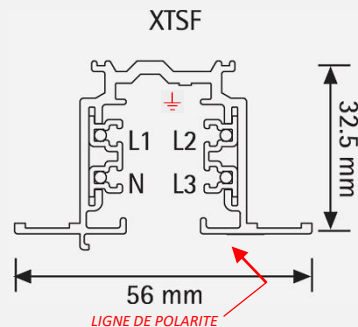
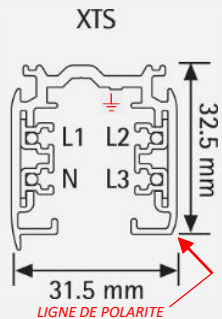

XTS 11 - \*  
VUE DU HAUT  
XTS 12 - \*

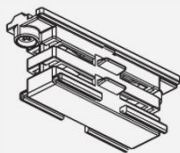

XTS 21 - \* Jonction électrique

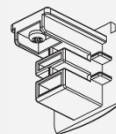

XTS 41 - \* Embout

XTS 11 - \* Embout d'alimentation  
XTS 12 - \* Embout d'alimentation

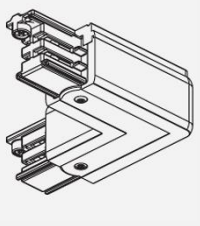

XTS 34 - \* Jonction 90°  
XTS 35 - \* Jonction 90°

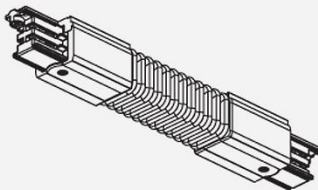

XTS 23 - \* Jonction flexible

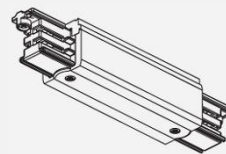

XTS 14 - \* Alimentation centrale

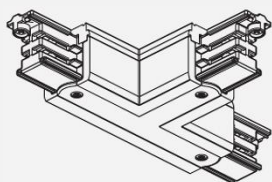

XTS 36 - \* XTS 39 - \*  
XTS 37 - \* XTS 40 - \*

XTS 36 - \* Jonction T  
XTS 37 - \* Jonction T  
XTS 39 - \* Jonction T  
XTS 40 - \* Jonction T

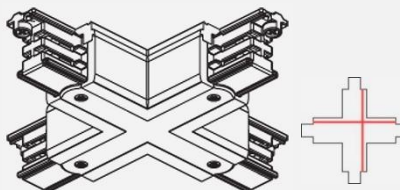

XTS 38 - \* Jonction X

\* = finition : gris (1) / noir(2) / blanc (3) / alu anodisé (9)

# EURO TRACK – 3A

## Rail apparent

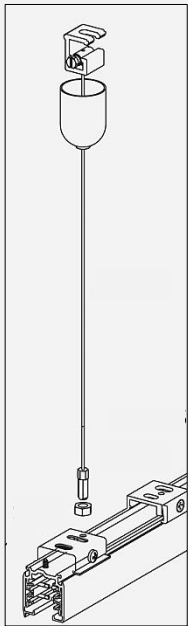
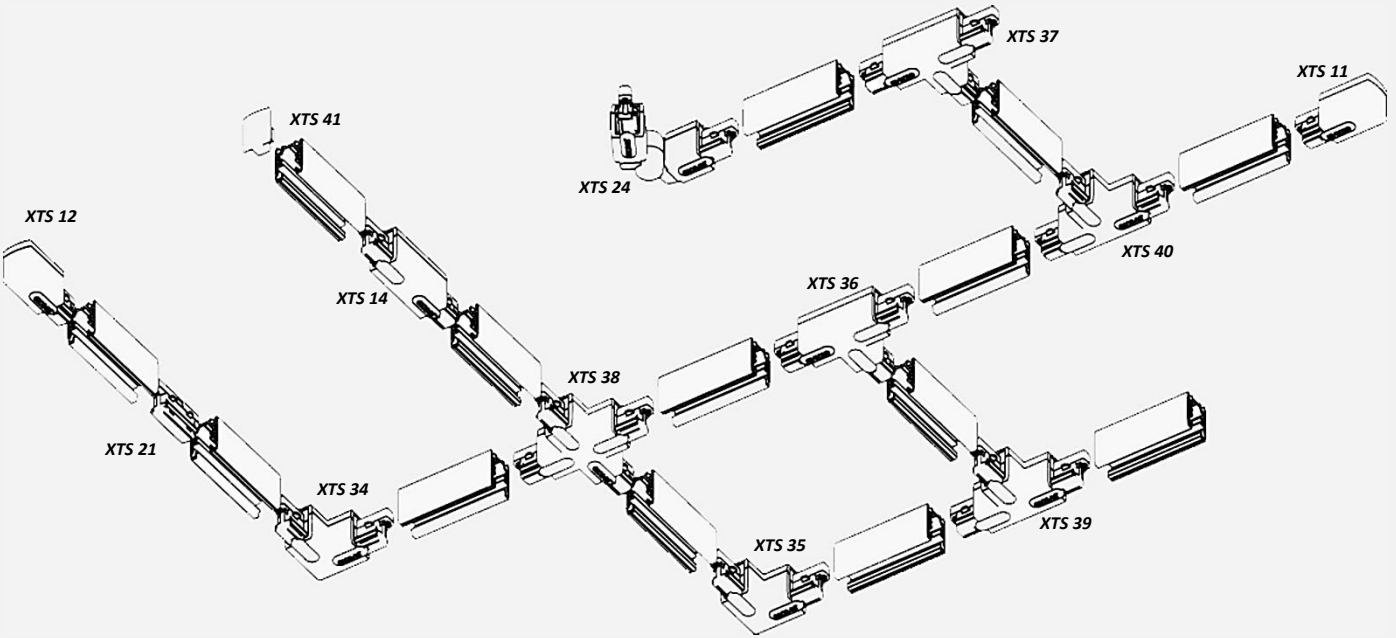

**SPW 1 - \***

Kit de suspension 1,5M

**SPW 3 - \***

Kit de suspension 3,0M

\* = finition uniquement disponible en: noir (2) / blanc (3)

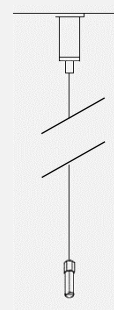

**KTSP1**

Kit de suspension 1,5M

**KTSP3**

Kit de suspension 3,0M

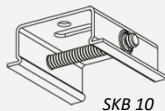

SKB 10

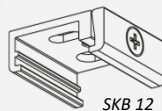

SKB 12

**SKB 10 - \***

Pour SPW et KTSP

**SKB 12 - \***

Suspension de plafond

# EURO TRACK – 3A

## Adaptateurs & accessoires

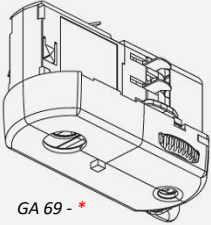

GA 69 - \*

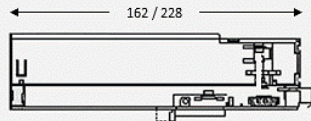

GA 016 - \* / GA 0167- \* / GA 2020- \*



XTSA 57



GA 510 - \*

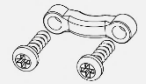

CG 69

GA 69 - *	Adaptateur universel
GA 016 - *	Adaptateur / driver LED intégré 700mA -> 850mA
GA 017 - *	Adaptateur / driver LED intégré 500mA -> 650mA
GA 2020 - *	Adaptateur / driver LED intégré 300mA -> 440mA

XTSA 57/8-9	Nipple M10*1 pour GA69 Finition aluminium
XTSA 57/12-2	Nipple M10*1 pour GA69 Finition noir
GA 510 - *	Serre câble apparent pour GA69
CG 69	Serre câble intérieur pour GA69

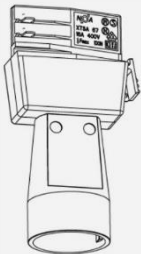

XTSA 67 S - \*

Adaptateur prise

\* = finition uniquement disponible en: noir (2) / blanc (3)

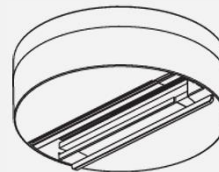

GA 70 - \*

Base apparente pour adaptateur 3A



XTAK 142 - \*

Crochet pour fil 2MM

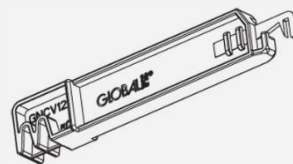

XTSV 12

Outil de coupe